

# IK-12 BEETLE

PORTABLE AUTOMATIC GAS CUTTING MACHINE

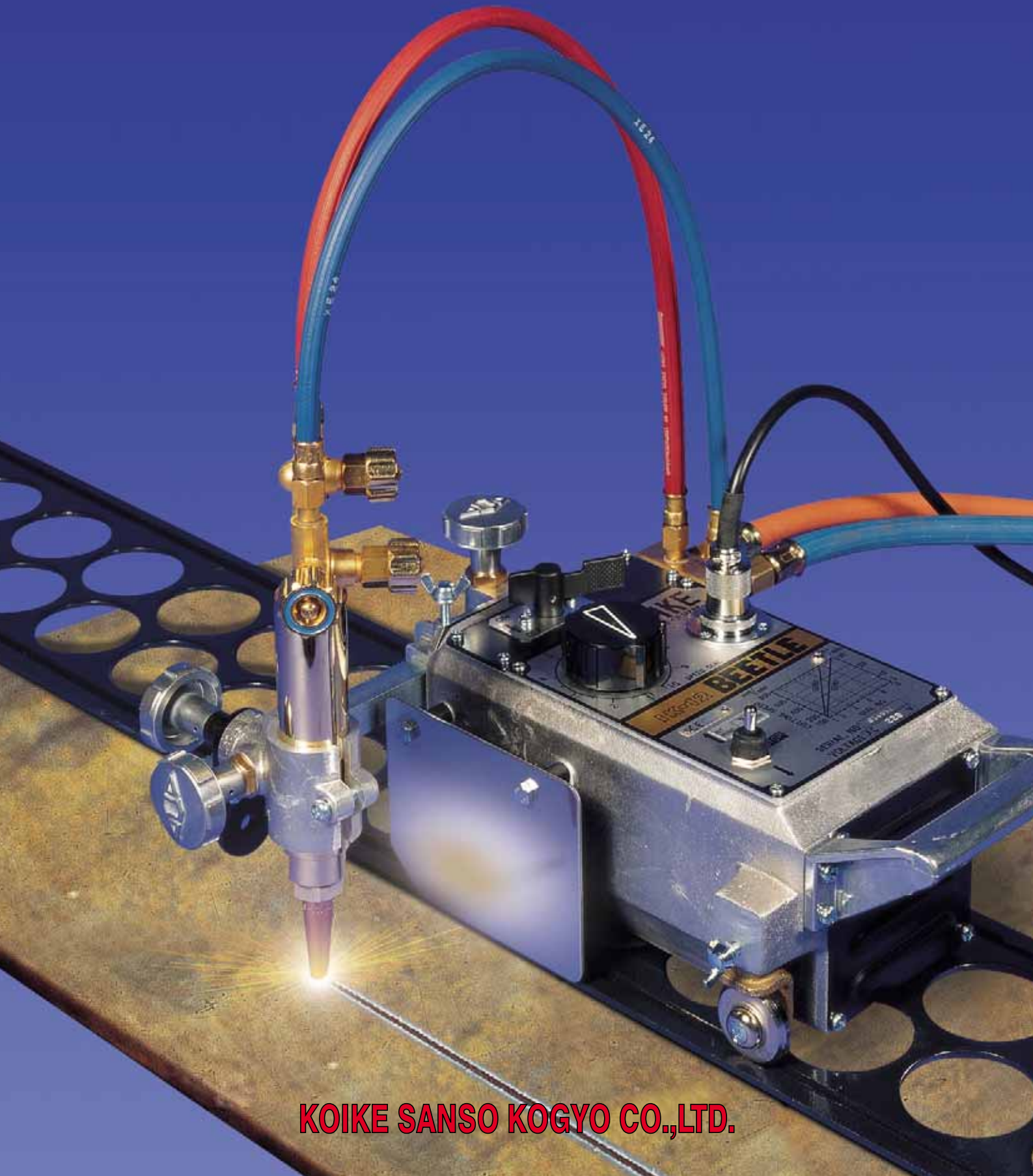

**KOIKE SANSO KOGYO CO.,LTD.**

**The IK-12 BEETLE is a more portable version of the IK-12 MAX (Koike high quality motor driven portable cutting machine), designed without any loss of accuracy and capability.**

- All functions controlled by forward/off/reverse switch, clutch lever and speed adjustment knob.
- Versatility and convertability inherent in the design ensure all types of straight line, circle, and bevel cutting are simply performed.
- The drive unit employing the single cone system (mechanical stepless variation device) assures constantly stable machine travel.
- Plate track for straight line cutting is available in sections of 1.800 mm (70") each which may be extended indefinitely.
- An adjustable radius bar for circle cutting is optionally available.
- The torch holder makes the bevel cutting of the lower edge possible, and the torch up/down unit is easy to handle and durable.
- Light in weight 9,5 kg (20,9 lbs) for handling and transportation.
- Two torch model available for parallel cutting with spacing of 80~300 mm (3~12").



One Torch



Two Torch

**Cutting versatility**

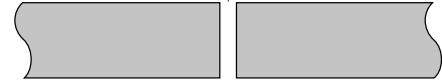

Square cutting (I)  
(with one torch)

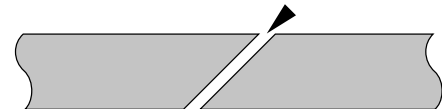

V-bevel cutting  
(with one torch)

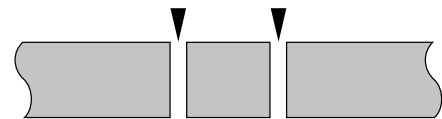

Square cutting (II)  
(with two torches)

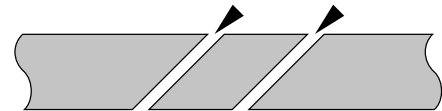

V-bevel cutting  
(with two torches)

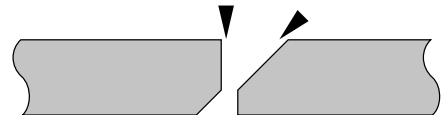

Y-bevel cutting  
(with two torches)

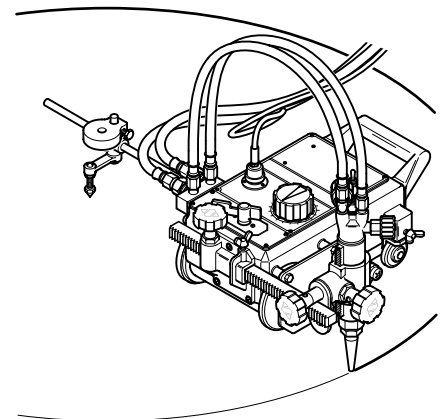

**Specifications**

Cutting thickness	5~100 mm (0,25~4")
Cutting speed	150~800 mm (6~32")/ min.
Speed control	Single cone system
Power	42/110/220V AC
Weight	9,5 kg (20,9 lbs) (one torch model) 13 kg (28,6 lbs) (two torch model)

**Included accessories**

Standard accessories delivered with the IK-12 BEETLE are:  
5 m (196") cabtyre cord, # 0-1-2 tips (100 Series for any fuel gas),  
tip cleaner, lighter, tool set, 3 hoses (from torch to valve).

**Optional accessories**

- 1,8 m (70") rail
- Circle cutting attachment 50~2.400 mm Ø (2~96" Ø)
- Circle cutting rail 40~1.150 mm Ø (1,5~45" Ø)



**KOIKE INTERNATIONAL GROUP**

**KOIKE EUROPE B.V.**

Grote Tocht 19,  
1507 CG Zaandam, Holland.  
Tel: +31 (0)75 - 612 72 27  
Fax: +31 (0)75 - 670 22 71  
www.koike.nl

**KOIKE FRANCE S.A.R.L.**

BP 58, 59584 Marly Cedex  
Tel: +33 (0)3 - 2730 4343  
Fax: +33 (0)3 - 2730 1250

**KOIKE UK Ltd**

97 Ashkirk  
Dudley, Cramlington  
Northumberland  
NE23 7DG  
Tel: +44 (0)191 250 17 18  
Fax: +44 (0)191 250 29 03

**KOIKE SANSEI  
KOGYO CO.,LTD.**  
www.koikeox.co.jp

**KOIKE KOREA  
ENGINEERING CO.,LTD.**

**KOIKE ARONSON, INC.**  
www.koike.com

Specifications shown herein are subject to chance without notice.

Distributed by:

