

Operation instruction • english  
Gebrauchsanweisung • deutsch  
Gebruiksaanwijzing • nederlands  
Manuel d'utilisation • français

1906530E  
0712

# FASTMIG™

MSF 53

MSF 55

MSF 57



---

# CONTENTS

<b>1. PREFACE</b> .....	3
1.1. INTRODUCTION.....	3
1.2. PRODUCT INTRODUCTION .....	3
1.2.1. OPERATION CONTROL AND CONNECTORS .....	4
1.2.2. CONNECTION OF SYSTEM .....	7
1.2.3. PARTS OF WIRE FEED MECHANISM, MSF 53, MSF 55, MSF 57 .....	8
1.3. OPERATION SAFETY.....	9
<b>2. INSTALLATION</b> .....	10
2.1. ASSEMBLY OF MIG SYSTEM.....	10
2.2. ACCESSORIES CORRESPONDING TO WIRE DIAMETER.....	10
2.3. MOUNTING OF MIG WELDING GUN .....	10
2.4. MOUNTING AND LOCKING OF WIRE REEL.....	11
2.5. AUTOMATIC WIRE FEED TO GUN .....	11
2.6. ADJUSTMENT OF PRESSURE.....	12
2.7. ADJUSTMENT OF TIGHTNESS OF REEL BRAKE.....	12
2.8. BURN BACK TIME .....	12
2.9. GROUND CABLE.....	12
2.10. SHIELD GAS.....	12
2.10.1. INSTALLING GAS BOTTLE .....	13
2.11. MAIN SWITCH I/O.....	13
2.12. OPERATION OF COOLING UNIT, FASTCOOL 10.....	13
2.13. HANGING.....	13
<b>3. CONTROL PANELS OPERATIONS</b> .....	14
3.1. SF 51 AND SF 54 OPERATIONS.....	14
3.2. SF 52 AND SF 53 OPERATIONS.....	16
3.3. SETUP FUNCTIONS (10) .....	22
<b>4. OPERATIONS OF REMOTE CONTROL UNITS IN MSF WIRE FEED UNIT</b> .....	24
<b>5. FASTMIG™ ERROR CODES</b> .....	25
<b>6. SERVICE, OPERATION DISTURBANCES</b> .....	26
<b>7. DISPOSAL OF THE MACHINE</b> .....	27
<b>8. ORDERING NUMBERS</b> .....	27
<b>9. TECHNICAL DATA</b> .....	29
<b>10. TERMS OF GUARANTEE</b> .....	30

---

# 1. PREFACE

## 1.1. INTRODUCTION

Congratulations on having purchased this product. Properly installed Kemppi products should prove to be productive machines requiring maintenance at only regular intervals. This manual is arranged to give you a good understanding of the equipment and its safe operation. It also contains maintenance information and technical specifications. Read this manual from front to back before installing, operating or maintaining the equipment for the first time. For further information on Kemppi products please contact us or your nearest Kemppi distributor.

The specifications and designs presented in this manual are subject to change without prior notice.

In this document, for danger to life or injury the following symbol is used: 

Read the warning texts carefully and follow the instructions. Please also study the Operation safety instructions and respect them when installing, operating and servicing the machine.

## 1.2. PRODUCT INTRODUCTION

Kemppi FastMig™ MSF is wire feeder designed for demanding professional use.

From our product family you can choose equipment intended either for 200-mm or 300-mm wire reel due to purpose of use. MSF 53 suits for 200-mm and MSF 55 and MSF 57 for 300-mm wire reel.

For both wire feeder units there are two alternative panels; simple and advanced panels. Alternative panels for MSF 53 are SF 51 and SF 52, panels for MSF 55 and MSF 57 are SF 53 and SF 54.

Operations of wire feed unit are controlled and adjusted with microprocessor.

This manual provides instructions on the start-up of the MSF 53, MSF 55 and MSF 57 MIG units and panels SF 51, SF 52, SF 53 and SF 54 as well as the functions of the wire feed unit.

 **This equipment's electromagnetic compatibility (EMC) is designed for use in an industrial environment. Class A equipment is not intended for use in residential location where the electrical power is provided by the public low-voltage supply system.**

## 1.2.1. Operation control and connectors

### MSF 53



Operation panel

Connection of remote control unit

Connection of welding gun EURO

Shield gas flow control

Lead-in and clamping of cooling liquid hoses



Connection for control cable

Shielding gas connection

Welding current cable connector

### MSF 55



Operation panel

Assembly space for push/pull gun control connector (accessory)

Connection of welding gun EURO

Connection of remote control unit



Shielding gas connection

Connection for control cable

Welding current cable connector

Lead-in and clamping of cooling liquid hoses

### MSF 57



Operation panel

Assembly space for push/pull gun control connector (accessory)

Connection of welding gun EURO

Connection of remote control unit



Shielding gas connection

Connection for control cable

Welding current cable connector

Lead-in and clamping of cooling liquid hoses

## Functions of SF 51 and SF 54 function panel

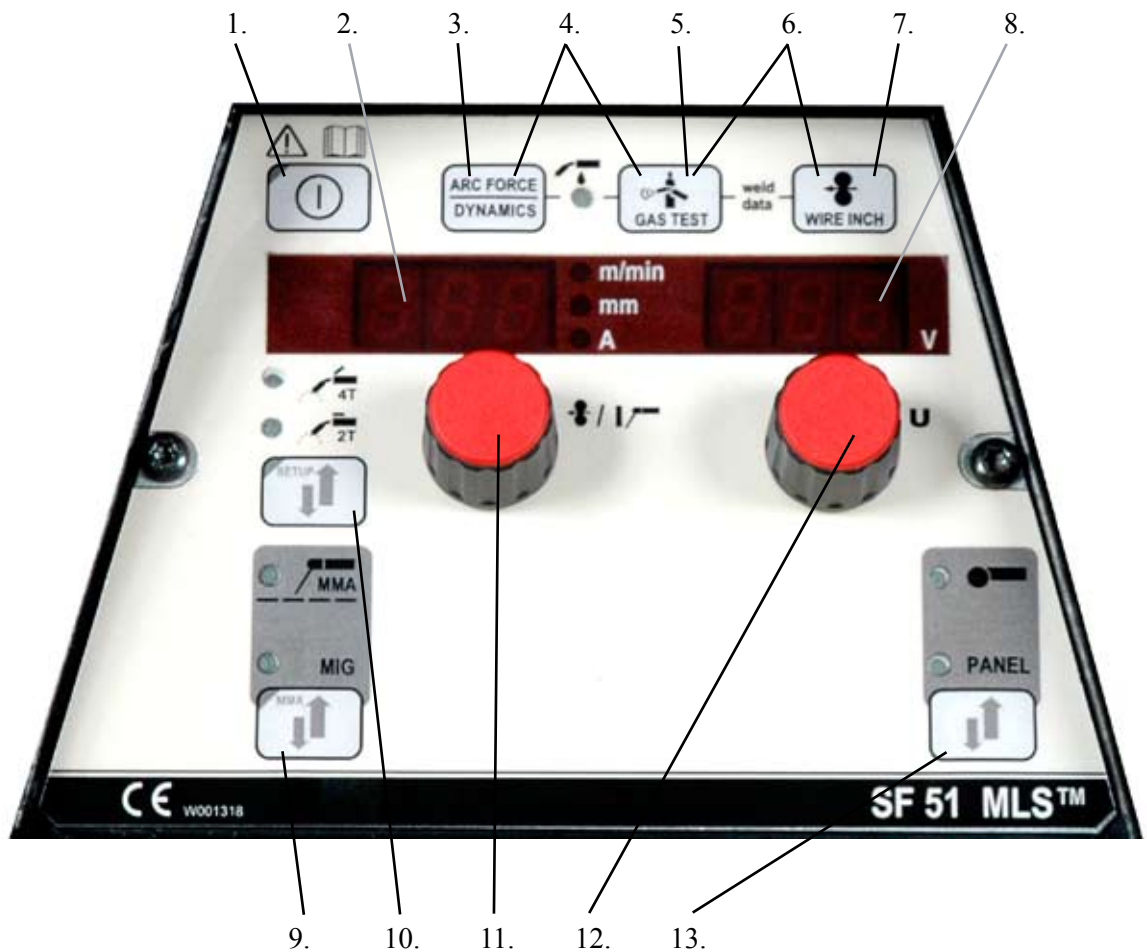

1. Main switch
2. Display of wire feed speed/welding current
3. Selection of MIG dynamics for adjustments
4. Selection of gas/water cooled MIG gun
5. Gas purge
6. Weld data: Last used welding parameters shown in displays
7. Wire inch
8. Display of set value of welding voltage/voltage during welding
9. Selection of MIG/MMA process
10. a) Selection of gun switch function  
b) Changing of basic parameters of the unit, SETUP (long pressing)
11. a) Adjustment of wire feed speed  
b) Selection of SETUP parameters
12. a) Adjustment of welding voltage  
b) Adjustment of MIG dynamics  
c) Adjustment of SETUP parameters
13. Manual control/remote control unit selection

## Functions of SF 52 and SF 53 function panel

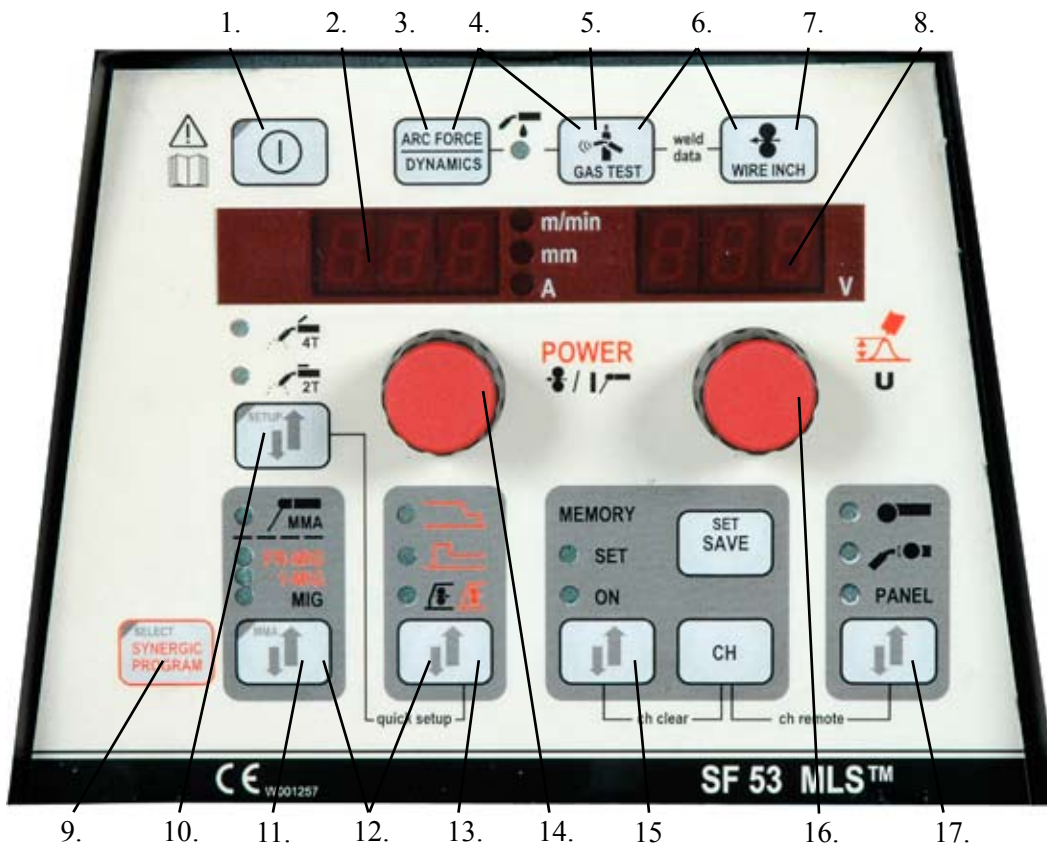

1. Main switch
  2. a) Wire feed speed/welding current/sheet strength display  
b) Display of selected adjustable parameter
  3. Activation of welding dynamics adjustment
  4. Selection of gas/water cooled MIG gun
  5. Gas purge
  6. Weld data: Last used welding parameters shown in displays
  7. Wire inch
  8. a) Welding voltage display  
b) Display of value of selected adjustable parameter
  9. 1-MIG selection check/1-MIG welding arc selection activation
  10. a) Selection of MIG process: 2T/4T  
b) Changing of basic parameters of the unit, SETUP (long pressing)
  11. Selection of welding process MIG, 1-MIG, MMA, FR-MIG \*)
  12. Activation of additional MIG function parameter adjustment
  13. Selection of additional MIG functions
  14. a) Adjustment of wire feed speed  
b) Adjustment of welding power setting (1-MIG)  
c) Adjustment of rod current  
d) Selection of SETUP parameter  
e) Selection of 1-MIG arc (material)
  15. Memory channels, storage of MIG parameters
  16. a) Welding voltage display  
b) Adjustment of length of welding arc (1-MIG)  
c) Adjustment of MIG dynamics  
d) Adjustment of SETUP parameter  
e) Selection of 1-MIG arc
  17. Manual control/remote control unit selection
- \*) FR-MIG for root pass welding is not included in standard delivery.

## 1.2.2. Connection of system

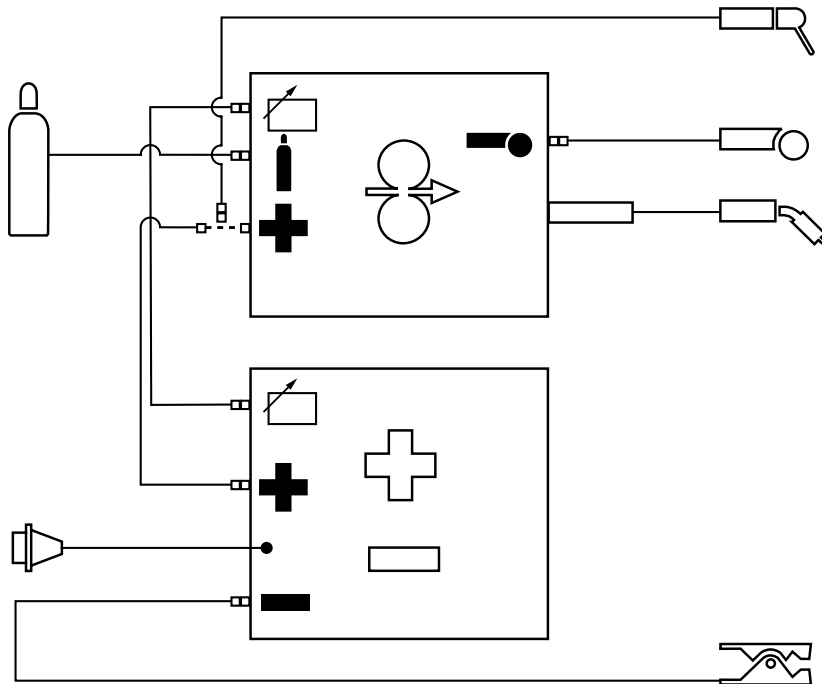
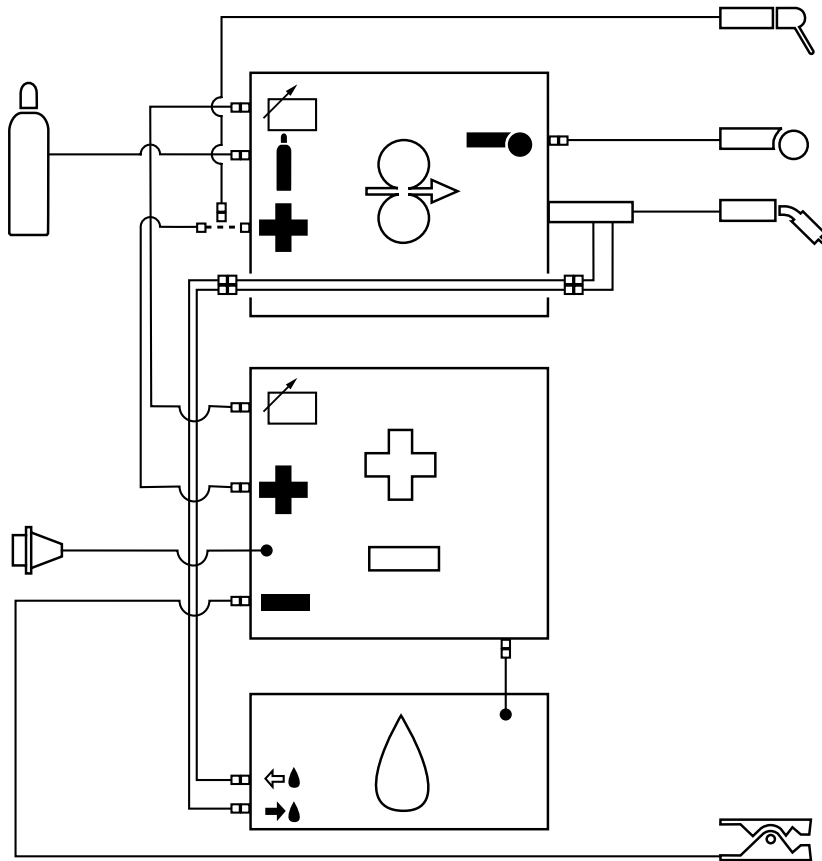

### 1.2.3. Parts of wire feed mechanism, MSF 53, MSF 55, MSF 57

## DuraTorque™ 400 4 - roll wire feed mechanism



### Wire guide tubes

Ss, Al Fe, Mc Fc	ø 0,6...1,6 mm	→	ø 2,5/64 mm W000762 silver, plastic	→	ø 2,5/33 mm W000956 silver, plastic	→	ø 2,0 mm W000624 plastic
	ø 1,6...2,4 mm	→	ø 3,5/64 mm W001430 silver, plastic	→	ø 3,5/33 mm W001431 silver, plastic	→	ø 3,5 mm W001389 plastic
Fe Mc Fc	ø 0,6...0,8 mm	→	ø 1,0/67 mm W001432 white, steel	→	ø 2,0/33 mm W001435 orange, steel	→	ø 2,0 mm W000624 plastic
	ø 0,9...1,6 mm	→	ø 2,0/64 mm W001433 orange, steel	→		ø 3,5 mm W001389 plastic	
	ø 1,6...2,4 mm	→	ø 4,0/63 mm W001434 blue, steel	→	ø 4,0/33 mm W001436 blue, steel	→	ø 3,5 mm W001391 brass

### Feed rolls

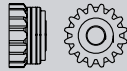

Fe Ss Al	Plain	0,6	1	W001045	pale grey
		0,6	2	W001046	pale grey
		0,8/0,9	1	W001047	white
		0,8/0,9	2	W001048	white
		1,0	1	W000675	red
		1,0	2	W000676	red
		1,2	1	W000960	orange
		1,2	2	W000961	orange
		1,4	1	W001049	braun
		1,4	2	W001050	braun
		1,6	1	W001051	yellow
		1,6	2	W001052	yellow
		Fe Fc Mc	Knurled	1,0	1
1,0	2			W001058	red
1,2	1			W001059	orange
1,2	2			W001060	orange
1,4/1,6	1			W001061	yellow
1,4/1,6	2			W001062	yellow
2,0	1			W001063	grey
2,0	2			W001064	grey
2,4	1			W001065	black
2,4	2			W001066	black
Fe Fc Mc Ss Al	U-groove	1,0	1	W001067	red
		1,0	2	W001068	red
		1,2	1	W001069	orange
		1,2	2	W001070	orange
		1,6	1	W001071	yellow
		1,6	2	W001072	yellow

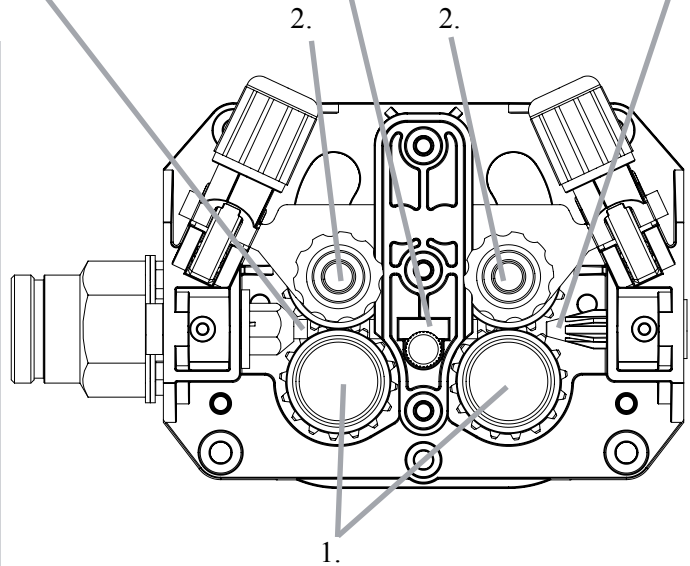

1 = drawing feed roll, 2 = pressing feed roll

---

## 1.3. OPERATION SAFETY

Please study these Operation safety instructions and respect them when installing, operating and servicing the machine.

### ***Welding arc and spatters***

Welding arc will hurt unprotected eyes, also be very careful with reflecting arc flash. Welding arc and spatter will burn unprotected skin. Therefore it is highly recommended to always use safety gloves and protective clothing.

### ***Danger for fire or explosion***

Pay attention to fire safety regulations. Remove flammable or explosive materials from welding area. Always reserve sufficient fire-fighting equipment on welding area. Be prepared for hazards in special welding jobs, eg. for the danger of fire or explosion when welding container type work area. Note! Fire can break out from sparks even several hours after the welding work has been finished!

### ***Mains voltage***

Never take welding machine inside a work area (eg. container or truck). Do not place welding machine on a wet surface. Always check cables before operating the machine. Change defect cables without delay. Defect cables may cause an injury or set out a fire. Connection cable must not be compressed, it must not touch sharp edges or hot work pieces.

### ***Welding power circuit***

Isolate yourself by using proper protective clothing, do not wear wet clothing. Never work on a wet surface or use defect cables. Do not put MIG-gun or welding cables on welding machine or on other electric equipment. Do not press MIG-gun switch, if the gun is not directed towards a work piece.

### ***Welding fumes***

Take care that there is sufficient ventilation during welding. Take special safety precautions when welding metals, which contain lead, cadmium, zinc, mercury or beryllium.

---

## 2. INSTALLATION

### 2.1. ASSEMBLY OF MIG SYSTEM

Assemble the units in order mentioned below and follow mounting and operation instructions which are delivered in packages.

#### 1. Installation of power source

Read paragraph: "Installation" in operation instructions for Kemppi FastMig™ power sources and carry out the installation according to that.

#### 2. Mounting of KMS power sources to transport wagon

Read and follow the instructions given in the transport cart installation/assembly manual

#### 3. Mounting the FastMig™ MSF on to the power source

Screw the fastening pivot on the power source. Lift the wire feeder on fastening pivot.

#### 4. Connecting cables

Connect the cables in accordance with the equipment notes provided.

The polarity of the welding wire (+ or -) can be changed by replacing the MSF welding current cable and return current cable with the Kemppi FastMig™ power source welding cable connector.

#### 5. Mounting of FastMig™ wire feed units to boom

 **Wire feed unit must be mounted to boom in such a way that its chassis is galvanic separated both from swing arm and boom.**

Suspension angle of wire feed unit can be changed by moving fixing point in handle.

### 2.2. ACCESSORIES CORRESPONDING TO WIRE DIAMETER

Wire feed rolls are available with plain groove, knurled groove and with U groove for different purposes.

**Feed rolls with plain groove:** Universal feed roll for welding of all kinds of wires.

**Feed rolls with knurled groove:** Special feed roll for cored wires and steel wires.

**Feed rolls with U groove:** Special feed roll for aluminium wires.

In delivery FastMig™ wire feed units are equipped with 1.2 mm orange feed rolls with V-groove and with silver wire guide tubes for welding filler wires of 0.6 – 1.6 mm.

### 2.3. MOUNTING OF MIG WELDING GUN

In order to ensure trouble-free welding check in operation instructions of gun used by you that wire guide tube and contact tip of gun are according to manufacturer's recommendation suitable to be used for wire feed diameter and type in question. To tight a wire guide tube might cause for wire feed unit a bigger stress than normally as well as disturbances in wire feed.

Screw snap connector of gun tight that there won't come any voltage losses on connecting surface.

A loose connection will heat gun and wire feed unit and feeder.

MSF wire feed units are equipped with backup functions in case of overheating of the liquid-cooled PMT gun or overloading of the wire feed motor. The backup function is as follows (see also the error code information, page 21):

1. The Kemppi PMT gun thermal protection goes into action. When this occurs, the unit interrupts welding and the message 'Err 153' appears on the panel (Is) display.
2. The wire feed motor can overload - due to, e.g., gun clogging. In this event, the unit interrupts welding and the text 'Err 162' appears on the panel display. 'Err 161' = warning.

Error codes disappear on the next start-up if the cause of the error has been eliminated (i.e., the gun has cooled down or the motor is no longer overloaded).

## 2.4. MOUNTING AND LOCKING OF WIRE REEL

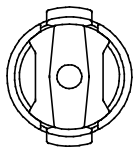

**LOCKED**

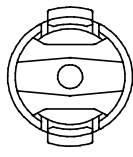

**OPEN**

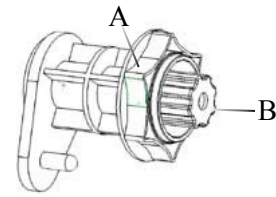

- Release locking nails of wire reel hub by turning locking knob a quarter round.
- Mount the reel at its place. Note rotating direction of reel!
- Lock the reel with locking knob, locking nails of hub remain to outside position and will lock the reel.
- Release the locking nub (A)!
- Mount the reel at its place. Note rotating direction of reel
- Lock the reel with locking nut.



**Check that in filler wire reel there are no parts sticking out, which could e.g. chafe against chassis or door of wire feed unit. Dragging parts might expose chassis of wire feed unit under voltage.**

## 2.5. AUTOMATIC WIRE FEED TO GUN

Automatic wire feed makes change of wire reel more rapid. In reel change the pressure of feed rolls need not to be released and filler wire goes automatically to correct wire line.

- Make sure that groove of feed roll matches the diameter of welding wire used.
- Release the wire end from reel and cut off the bent length. Be careful that the wire does not spill from the reel to sides!
- Straighten about 20 cm of the wire and see that the end of it has no sharp edges (file off if necessary). A sharp edge may damage the wire guide tube and contact tip of the welding gun.

### **FastMig™ MSF wire feed units:**

- Draw a bit of loose wire from wire reel. Feed wire through back liner to feed rolls. Do not release pressure of feed rolls!
- Press the gun switch and feed a bit wire until wire goes through feed rolls to gun. See that wire is in grooves of both feed roll pairs!
- Press still the gun switch until wire has come through contact tip.

Automatic feed may sometimes fail with thin wires (Fe, Fc, Ss: 0,6...0,8 mm, Al: 0,8...1,0 mm). In that case you might have to open feed rolls and feed wire manually through feed rolls.

## 2.6. ADJUSTMENT OF PRESSURE

Adjust the pressure of feed rolls with the control screw (20) so that the wire is fed into the wire guide tube evenly and allows a little braking when coming out from the contact tip without slipping at the feed rolls.



**Excessive pressure causes flattening of the filler wire and damage to the coating. It also causes undue wear of the feed rolls as well as friction.**

## 2.7. ADJUSTMENT OF TIGHTNESS OF REEL BRAKE

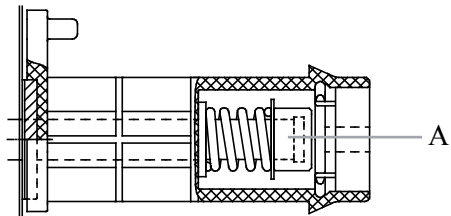

Brake force is adjusted through hole in locking device of reel hub by screwing the control screw (A) with screwdriver.

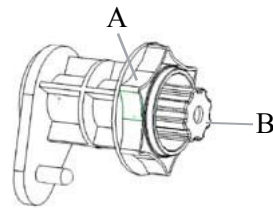

Brake force is adjusted by screwing the brake force adjusting screw (B), tightening clockwise direction.

Adjust brake force as so big that the wire is not allowed to become too loose on the reel so that it would spill from the reel when the rotation of the reel stops. Need for brake force is increased with increase of wire feed speed.

Since the brake loads for its part the motor, you shouldn't keep it unnecessarily tight.

## 2.8. BURN BACK TIME

Electronics of feed unit controls stopping of welding automatically so that the wire end doesn't melt fastened to the contact tip or the work piece. Automatics work regardless of the wire feed speed. Can be adjusted also from SETUP-menu ('PoC').

## 2.9. GROUND CABLE

Connecting of earth cable should be preferably connected directly to the welding material. Contact surface of press always should be as large as possible.

Clean the fastening surface from paint and rust!

Use in your MIG equipment at least 70 mm<sup>2</sup>. Thinner cross-sectional areas might cause overheating of connectors and insulations.

Make sure that the welding gun in your use is designed for max. welding current needed by you!  
Never use a damaged welding gun!

## 2.10. SHIELD GAS



**Handle gas bottle with care. There is a risk for injury if gas bottle or bottle valve is damaged!**

For welding stainless steels, mixed gases are normally used. Check that the gas bottle valve is suitable for the gas. The flow rate is set according to the welding power used in the job. A suitable flow rate is normally 8 – 10 l/min. If the gas flow is not suitable, the welded joint will be sporous. Contact your local Kemppi-dealer for choosing gas and equipment.

### 2.10.1. Installing gas bottle

**⚠** Always fasten gas bottle properly in vertical position in a special holder on the wall or on a carriage. Remember to close gas bottle valve after having finished welding.

#### Parts of gas flow regulator

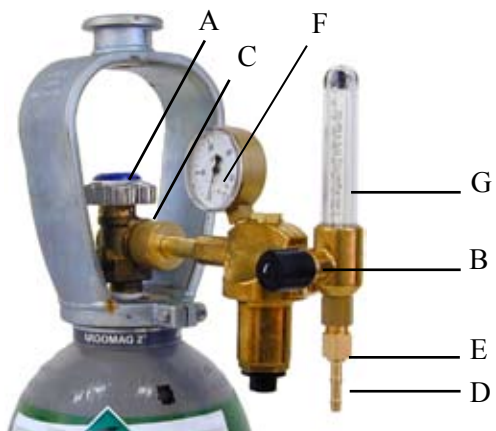

- A Gas bottle valve
- B Press regulation screw
- C Connecting nut
- D Hose spindle
- E Jacket nut
- F Gas bottle pressure meter
- G Gas hose pressure meter

The following installing instructions are valid for most of the gas flow regulator types:

1. Step aside and open the bottle valve (A) for a while to blow out possible impurities from the bottle valve.
2. Turn the press regulation screw (B) of the regulator until no spring pressure can be felt.
3. Close needle valve, if there is one in the regulator.
4. Install the regulator on bottle valve and tighten connecting nut (C) with a wrench.
5. Install hose spindle (D) and jacket nut (E) into gas hose and tighten with hose clamp.
6. Connect the hose with the regulator and the other end with the wire feed unit. Tighten the jacket nut.
7. Open bottle valve slowly. Gas bottle pressure meter (F) shows the bottle pressure. Note! Do not use the whole contents of the bottle. The bottle should be filled when the bottle pressure is 2 bar.
8. Open needle valve if there is one in the regulator.
9. Turn regulation screw (B) until hose pressure meter (G) shows the required flow (or pressure). When regulating flow amount, the power source should be in switched on and the gun switch pressed simultaneously.

Close bottle valve after having finished welding. If the machine will be out of use for a long time, unscrew the pressure regulation screw.

### 2.11. MAIN SWITCH I/O

When you turn the main switch of the Kemppi FastMig™ power source into I-position, the pilot lamp closest to this switch will light up, indicating the power source is ready for welding. The equipment is returned to the position which it last carried out before the main switch was turned to zero position.

**⚠** Always start and switch off the machine with the main switch, never use the mains plug as a switch.

### 2.12. OPERATION OF COOLING UNIT, FASTCOOL 10

Operation of cooling unit is controlled in such a way that pump is started when welding is started. After welding stop pump is rotating for approx. 5 min cooling the gun and the cooling liquid to ambient temperature.

Read in operation instructions for the Fastcool 10 unit the trouble situations of the liquid circulation system and protection against torch etc. damage.

### 2.13. HANGING

MSF 53 needs hanging frame (accessorie) for mounting, do not hang from the handle. MSF 55 and MSF 57 can be hanged from hanging kit available as an accessorie.

## 3. CONTROL PANELS OPERATIONS

### 3.1. SF 51 AND SF 54 OPERATIONS

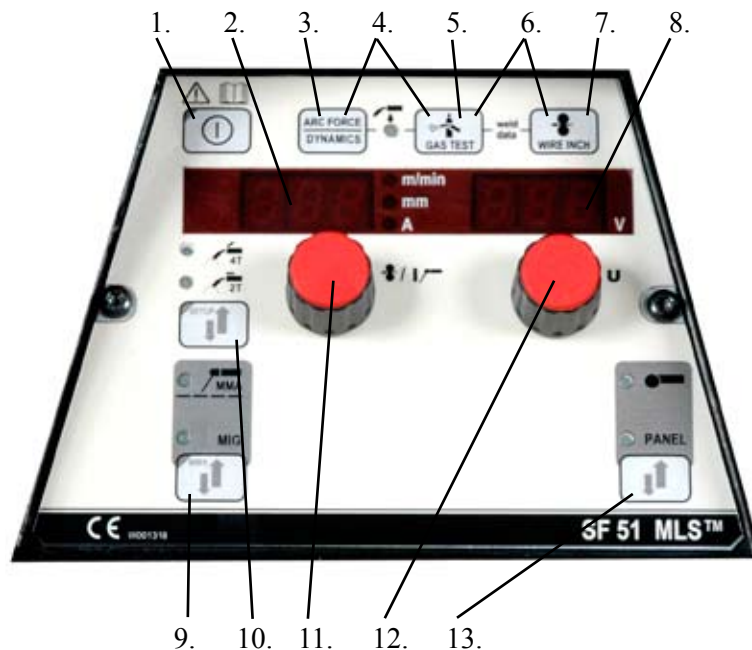

#### **Main switch, ON/OFF (1)**

The wire feed unit remains in the OFF position when the power source is switched on, thus preventing start-up. 'OFF' is shown on the display.

When the ON/OFF button is pressed for more than 1 second, the unit starts up. The unit is now ready for welding and will automatically return back to its previous position, before the power was cut off. The wire feed unit starts up also by pressing three (short) times the switch of the welding gun.

#### **Basic settings and displays (11, 12, 2, 8)**

The wire feed speed is set via potentiometer No. 11, the value of which is shown on display No. 2. The welding voltage is set via potentiometer No. 12, the value of which is shown on display No. 8. During welding, display No. 2 shows the actual welding current value and display No. 8 shows welding voltage.

When MIG dynamics adjustment is activated via button No. 3, the MIG dynamics value is adjusted through potentiometer No. 12 (see 'Adjustment of MIG dynamics').

With electrode welding (MMA), the welding current value is set via the potentiometer, the value of which is shown on display No. 2. Display 8 shows the idling voltage of the power source. During welding, display 2 shows the actual welding current value and display 8 shows the welding voltage.

When the adjustment of SETUP parameters has been confirmed with long press on button 10b, the adjustable parameter is selected via potentiometer No. 11, the name of which is shown on display No. 2. Parameter value is selected from potentiometer (12), value can be seen on display (8). (see the information on SETUP functions).

#### **Selection of MIG operating procedure (10a)**

MIG 2T: MIG welding with two-sequence procedure of welding gun start switch

1. switch pressed: welding starts
2. switch released: welding stops

MIG 4T: MIG welding with four-sequence procedure of welding gun start switch

1. switch pressed: shielding gas flow starts
2. switch released: welding starts
3. switch pressed: welding stops
4. switch released: shielding gas flow stops

---

### **Adjustment of MIG dynamics/Arc Force (3)**

With MIG welding dynamics adjustment is influenced on welding stability and spatter amount. Zero setting is recommended basic setting. Values → min (-1...-9), softer arc for reduced spatter amount. Values → max (1...9), harder arc for increased stability and when 100 % CO<sub>2</sub> shielding gas is used when welding steel.

With electrode welding Arc Force adjustment is influenced on welding stability. Adjustment is needed for using different types of electrodes. Control range (-9...0) is commonly used for welding electrodes for stainless steel. Control range (0...+9) is used for harder arc characteristic to increase stability, e.g. for welding with thicker basic electrodes and using lower current value than recommended. Factory set value (0) is a good general use for adjusting the roughness of the arc.

### **Gas test (5)**

The gas test button opens the gas valve without activating the wire feed or power source.

By default, gas flows for 20 seconds. The display shows the remaining gas flow time.

The default time for gas flow can be adjusted via the right-hand potentiometer within a 10- to 60-second range. The new time setting is recorded in the memory.

The gas flow can be discontinued by pressing the ON/OFF button or the start switch of the gun.

### **Wire feed test (7)**

The wire feed switch starts the wire feed motor without opening the gas valve and without engaging the power source. The default wire feed speed is 5 m/min. The speed can be adjusted via the right-hand potentiometer.

When the button is released, the wire feed stops. Unit operation returns to normal approx. 3 seconds after release of the button or if the ON/OFF button is pressed briefly.

### **Selection of liquid- /gas-cooled MIG gun (4)**

Selection of liquid-cooled/gas-cooled MIG gun is activated by pressing buttons 3 and 5 simultaneously (for more than 1 second). When 'Gas' is shown on the display, the welding equipment will assume that a gas-cooled MIG gun has been connected. If the above buttons are pressed again, the text 'CooLEr' appears on the display and the LED indicating liquid cooling selection lights up. In this case, the welding equipment will assume that a liquid-cooled MIG gun has been connected to the equipment. When liquid cooling is selected, the liquid cooling unit will start up in connection with the next equipment start-up.

### **Weld data (6)**

The weld data function is activated by pressing buttons 5 and 7 simultaneously. The weld data function returns the welding current and voltage values that were in use when welding was discontinued to the displays.

### **Selection of welding process (9)**

Electrode welding (MMA) is selected by pressing the button for >1 second. N.B.! When electrode welding is selected, the power source, the electrode holder connected to it and the MIG gun become energised (idling voltage).

### **Use of remote control units (13)**

Remote control unit is connected to the device by pressing button 13. The wire feed speed and welding voltage setting operations are performed via remote control. In this case, potentiometers 11 and 12 of the panel are disconnected.

## 3.2. SF 52 AND SF 53 OPERATIONS

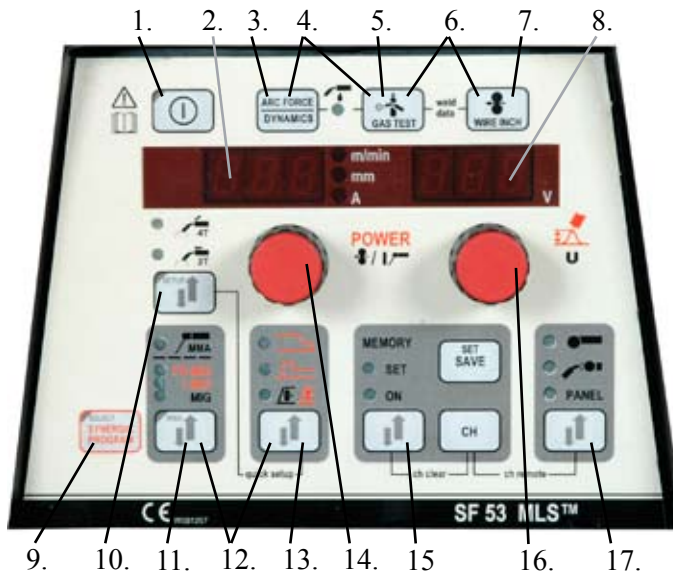

### **Main switch, ON/OFF (1)**

The wire feed unit remains in the OFF position when the power source is switched ON, thus preventing start-up. OFF is shown on the display. When the ON/OFF button is pressed for more than 1 second, the unit starts up. The unit is now ready for welding and will automatically return to previous position. The unit starts up also by pressing three times shortly the start switch of the gun.

### **Basic settings and displays (14, 16, 2, 8)**

With MIG welding, the wire feed speed is set via potentiometer No. 14, the value of which is shown on display No. 16. The welding voltage is set via potentiometer No. 16, the value of which is shown on display No. 8. During welding, display 2 shows the actual welding current value and display 8 shows the welding voltage.

With electrode welding (MMA), the welding current value is set via the potentiometer, the value of which is shown on display No. 2. Display 8 shows the idling voltage of the power source. During welding, display 2 shows the actual welding current value and display 8 shows the welding voltage.

When MIG dynamics/electrode welding Arc force adjustment is activated via button No. 3, the value is adjusted via potentiometer No. 16 (see the information on adjustment of MIG dynamics/arc force).

With Synergic 1-MIG welding, the power value is set via potentiometer 14 and the length of the arc via potentiometer 16 (see '1-MIG welding').

When the adjustment of SETUP parameters has been confirmed with a long press on button 10, the adjustable parameter is selected via potentiometer No. 14, the name of which is shown on display No. 2. The parameter's value is set via potentiometer No. 16, the value of which is shown on display No. 8 (see 'SETUP functions').

---

## **Selection of MIG operating procedure (10)**

MIG 2T: MIG welding with two-sequence procedure of welding gun start switch

1. switch pressed: welding starts
2. switch released: welding stops

MIG 4T: MIG welding with four-sequence procedure of welding gun start switch

1. switch pressed: shielding gas flow starts
2. switch released: welding starts
3. switch pressed: welding stops
4. switch released: shielding gas flow stops

## **Adjustment of MIG dynamics/Arc Force (3)**

With MIG welding dynamics adjustment is influenced on welding stability and spatter amount. Zero setting is recommended basic setting. Values → min (-1...-9), softer arc for reduced spatter amount. Values → max (1...9), harder arc for increased stability and when 100 % CO<sub>2</sub> shielding gas is used in welding of steel.

With electrode welding Arc Force adjustment is influenced on welding stability. Adjustment is needed for using different types of electrodes. Control range (-9...0) is commonly used for welding electrodes for stainless steel. Control range (0...+9) is used for harder arc characteristic to increase stability, e.g. for welding with thicker basic electrodes and using lower current value than recommended. Factory set value (0) is a good general use for adjusting the roughness of the arc.

## **Gas test (5)**

The gas test button opens the gas valve without activating the wire feed or power source. Gas flows for 20 seconds by default. The display shows the remaining gas flow time. The default time of gas flow can be adjusted via the right-hand potentiometer within a range of 10 to 60 seconds. The new time setting is recorded in the memory. The gas flow can be discontinued by pressing the ON/OFF button or the start switch of the gun.

## **Wire feed test (7)**

The wire feed switch starts the wire feed motor without opening the gas valve and without engaging the power source. The default wire feed speed is 5 m/min. The speed can be adjusted via the right-hand potentiometer. When the button is released, the wire feed stops. Operation returns to normal approx. 3 seconds after release of the button or if the ON/OFF button is pressed briefly.

## **Selection of liquid- /gas-cooled MIG gun (4)**

Selection of liquid-cooled/gas-cooled MIG gun is activated by pressing buttons 3 and 5 simultaneously (for more than 1 second). When 'Gas' is shown on the display, the welding equipment will assume that a gas-cooled MIG gun has been connected. If the above buttons are pressed again, the text 'CooLEr' appears on the display and the LED indicating liquid cooling selection lights up. In this case, the welding equipment will assume that a liquid-cooled MIG gun has been connected. When liquid cooling has been selected, the liquid cooling unit will start up in connection with the next equipment start-up.

## **Weld data (6)**

The weld data function is activated by pressing buttons 5 and 7 simultaneously. The weld data function returns the welding current and voltage values to the displays that were in use when welding was discontinued.

---

## **Selection of welding process (11)**

The welding process – normal MIG, 1-MIG or FR-MIG – can be chosen by the welding process selection button. In normal MIG welding wire feed speed and welding voltage is adjusted separately. In synergic 1-MIG and FR-MIG welding the welding voltage and other parameters related to welding are optimally bound to each other! In synergic welding the setting for power and arc length are adjusted.

FR-MIG welding is the facility provided separately, so the function is not in every equipment.

Electrode welding (MMA) is selected by pressing the button for >1 second. N.B.! When electrode welding is selected, the power source, the electrode holder connected to it and the MIG gun become energised (idling voltage).

## **Settings selection button (17)**

The settings selection button is used to choose the basic settings required. Active settings are indicated by an LED pilot lamp. Settings are performed manually via the panel potentiometers or remotely via the remote control unit linked to the unit's remote-control connector. If settings are chosen to be performed via the gun controller connected to the welding gun, the wire feed speed / setting for power (1-MIG) will be adjusted via the gun controller and the welding voltage/arc length (1-MIG) adjusted via panel potentiometer No. 16.

N.B.! Remote control or gun settings can be chosen only if the controller in question is connected to the equipment, and in gun control the SETUP parameter 'GUN' is position "ON".

## **Additional MIG functions (13)**

### **Activation of additional MIG functions**

Functions can be added to wire feeder by buying a specific code for it (=licence). The code can be programmed via wire feeder bus address or via panel. Instructions for programming the code via wire feeder bus address are on programming manual.

### **Programming from panel:**

1. Go to SETUP functions by a long press on button SETUP.
2. Choose with left potentiometer parameter Code Entering ('Cod') and adjust right potentiometer to Enter ('Ent').
3. Press shortly on REMOTE button.
4. You can see on left display number one (1), program the first value of the code on right potentiometer. Programmed value can be seen on right display.
5. Choose next value programming with the potentiometer on left.
6. Program the same value seen on left display with right potentiometer.
7. Go back to point 5, until all values of the code have been programmed.
8. Approve the code by a short press on button REMOTE.
9. If code programming is succeeded, on panel can be seen text 'Suc cEs'. If code programming failed, there is an error code on panel. (See 5. FastMig™ error codes).
10. You can remove from programming mode at any time by pressing shortly ON/OFF button (ESC function).

The selection button for additional MIG functions can be used to activate the slow start ('Creep Start'), hot start, or crater levelling ('Crater Level') function. Further presses of the selection button can select one or more of the above functions. N.B.! Only the available additional functions for each method can be selected.

Parameters related to these functions are set via the SETUP function (see 'SETUP functions').

The purpose of **Creep Start** is to facilitate the initial weld – e.g., when welding with a high wire feed speed. The wire feed speed is kept low until the wire touches the work piece and the current begins to flow. Creep Start can be selected with normal MIG welding or with Synergic 1-MIG welding.

---

The purpose of the **Hot Start** function is to reduce initial welding errors when welding highly heat-conductive materials such as aluminium. Hot Start can be selected when using Synergic 1-MIG welding and when the 4T operating mode is selected. In this case, when the start switch of the gun is held down, a fixed pre-gas time is displayed after which welding starts at the level determined by the SETUP mode's Hot Start parameter, returning to the normal level when the gun switch is released.

Stopping is performed as with the normal 4T function.

The purpose of **crater levelling** is to reduce welding defects caused by end cratering. The Crater Level function can be selected when using Synergic 1-MIG welding and when the 4T operating mode is selected.

When the gun switch is pressed down in connection with termination of welding, the welding power drops to the crater-filling level selected previously. The crater filling function is discontinued by releasing the gun switch.

The values of parameters related to additional MIG functions can be changed either with the **SETUP** function (see 'SETUP') or with the Quick SETUP function. Quick SETUP is activated by simultaneously pressing buttons 13 and 10. In this way, parameters related to MIG additional functions can be set.

Parameters are selected for adjustment either with button 13 or via potentiometer No. 14. The value of the parameter is set via potentiometer No. 16. The value is immediately recorded in the memory.

## **Memory functions (15)**

### **Storage of settings**

The memory functions can be used to record useful welding values in the memory. There are ten different memory locations: 0 ... 9.

In addition to welding values (wire feed speed, welding voltage), function options such as 2T/4T, Creep Start, and Crater Level are recorded in the memory.

Storage in memory is performed as follows:

1. Press the MEMORY button twice; the SET light begins to flash if the channel is not in use. If the channel is in use, the light remains lit. N.B.! If the memory is empty, press the MEMORY key once to get in SET mode.
2. Select the desired memory channel with the CH key.
3. Make the settings and store them in the memory by pressing the SAVE button.
4. Press the MEMORY key twice. Notice that the ON light is lit.
5. Begin welding.

If you wish to change some values, the light must be switched from the ON setting to the SET setting to enable you to select the required parameters. Press the SAVE button to complete the procedure. It is also possible to save the parameters of the current weld by pressing SET when the memory function is in OFF status (all lights off). The channel can be cleared by pressing MEMORY and the CH button simultaneously in SET mode.

Use of stored settings

1. Press the MEMORY button.
2. Select the memory channel via the CH button.
3. Begin welding.

The Ch remote function enables selection of memory channels via the selection controller located on the gun. The function is activated by pressing buttons 17 and CH simultaneously. When the CH-remote is activated the light in remote control or in gun control starts to flash.

## Synergic 1-MIG or FR-MIG welding (9, 11)

In Synergic 1-MIG welding, the optimal welding parameters for the welding wires and gas used are recorded in the unit. The welding is controlled by adjusting the welding power and arc length.

Synergic FR-MIG process is meant for root bass welding. Welding parametres and shape of short circuit responce are optimized for root bass welding.

### Welding arc/programme selection:

Before commencing welding, a welding arc/programme suited to the welding wire and gas used must be chosen from the instructions on the inner surface of the MSF door.

Arc selection is activated by pressing button No. 9 for >1 second. In this case, displays 2 and 8 begin to flash and the material group is selected from the left-hand potentiometer and the welding arc/programme for the material group in question from the right potentiometer; see the enclosed table.

FastMig™ synergic MIG-programs							
1-MIG				1-MIG			
Prog	Wire Ø mm	Material	Gas mixture	Prog	Wire Ø mm	Material	Gas mixture
<b>Fe-group</b>				<b>SS-group</b>			
101	0,8	Fe	Ar+18%-25%CO <sub>2</sub>	201	0,8	SS-316	Ar+2%CO <sub>2</sub>
102	0,9	Fe	Ar+18%-25%CO <sub>2</sub>	202	0,9	SS-316	Ar+2%CO <sub>2</sub>
103	1,0	Fe	Ar+18%-25%CO <sub>2</sub>	203	1,0	SS-316	Ar+2%CO <sub>2</sub>
104	1,2	Fe	Ar+18%-25%CO <sub>2</sub>	204	1,2	SS-316	Ar+2%CO <sub>2</sub>
106	1,6	Fe	Ar+18%-25%CO <sub>2</sub>	206	1,6	SS-316	Ar+2%CO <sub>2</sub>
111	0,8	Fe	CO <sub>2</sub>	211	0,8	SS-316	Ar+30%He+1%O <sub>2</sub>
112	0,9	Fe	CO <sub>2</sub>	212	0,9	SS-316	Ar+30%He+1%O <sub>2</sub>
113	1,0	Fe	CO <sub>2</sub>	213	1,0	SS-316	Ar+30%He+1%O <sub>2</sub>
114	1,2	Fe	CO <sub>2</sub>	214	1,2	SS-316	Ar+30%He+1%O <sub>2</sub>
116	1,6	Fe	CO <sub>2</sub>	216	1,6	SS-316	Ar+30%He+1%O <sub>2</sub>
121	0,8	Fe	Ar+8%CO <sub>2</sub>	221	0,8	SS-309	Ar+2%CO <sub>2</sub>
122	0,9	Fe	Ar+8%CO <sub>2</sub>	222	0,9	SS-309	Ar+2%CO <sub>2</sub>
123	1,0	Fe	Ar+8%CO <sub>2</sub>	223	1,0	SS-309	Ar+2%CO <sub>2</sub>
124	1,2	Fe	Ar+8%CO <sub>2</sub>	224	1,2	SS-309	Ar+2%CO <sub>2</sub>
126	1,6	Fe	Ar+8%CO <sub>2</sub>	231	0,8	SS-309	Ar+30%He+1%O <sub>2</sub>
152	0,9	FEMC	Ar+18%-25%CO <sub>2</sub>	232	0,9	SS-309	Ar+30%He+1%O <sub>2</sub>
154	1,2	FEMC	Ar+18%-25%CO <sub>2</sub>	233	1,0	SS-309	Ar+30%He+1%O <sub>2</sub>
164	1,2	FEMC	CO <sub>2</sub>	234	1,2	SS-309	Ar+30%He+1%O <sub>2</sub>
174	1,2	FEFC rutile	Ar+18%-25%CO <sub>2</sub>	242	0,9	FC-316	Ar+18%-25%CO <sub>2</sub>
184	1,2	FEFC rutile	CO <sub>2</sub>	244	1,2	FC-316	Ar+18%-25%CO <sub>2</sub>
194	1,2	FEFC basic	Ar+18%-25%CO <sub>2</sub>	252	0,9	FC-316	CO <sub>2</sub>
				254	1,2	FC-309L	Ar+18%-25%CO <sub>2</sub>

FastMig™ synergic MIG-programs							
1-MIG				FR-MIG			
Prog	Wire Ø mm	Material	Gas mixture	Prog	Wire Ø mm	Material	Gas mixture
<b>Al-group</b>				<b>Fe-group</b>			
303	1,0	Al-5356	Ar	902	0,9	Fe	Ar+18%-25%CO <sub>2</sub>
304	1,2	Al-5356	Ar	903	1,0	Fe	Ar+18%-25%CO <sub>2</sub>
306	1,6	Al-5356	Ar	904	1,2	Fe	Ar+18%-25%CO <sub>2</sub>
313	1,0	AL-4043	Ar	912	0,9	Fe	CO <sub>2</sub>
314	1,2	Al-4043	Ar	913	1,0	Fe	CO <sub>2</sub>
316	1,6	Al-4043	Ar	914	1,2	Fe	CO <sub>2</sub>
<b>SPE-group</b>				<b>SS-group</b>			
401	0,8	CuSi 3	Ar	922	0,9	SS-136	Ar+2%CO <sub>2</sub>
402	0,9	CuSi 3	Ar	923	1,0	SS-316	Ar+2%CO <sub>2</sub>
403	1,0	CuSi 3	Ar	924	1,2	SS-316	Ar+2%CO <sub>2</sub>
404	1,2	CuSi 3	Ar	932	0,9	SS-316	Ar+30%He+1%O <sub>2</sub>
411	0,8	CuSi 3	Ar+2% CO <sub>2</sub>	933	1,0	SS-316	Ar+30%He+1%O <sub>2</sub>
412	0,9	CuSi 3	Ar+2% CO <sub>2</sub>	934	1,2	SS-316	Ar+30%He+1%O <sub>2</sub>
413	1,0	CuSi 3	Ar+2% CO <sub>2</sub>				
421	0,8	CuAl 8	Ar				
423	1,0	CuAl 8	Ar				
424	1,2	CuAl 8	Ar				

The selected programme is immediately recorded in the memory. To get back to normal status press ON/OFF (1) key, or Synergic PROGRAM button (9).

**Use of a selected welding arc/programme:**

Select the relevant welding process with the 1-MIG selection button (11). Check that the welding arc/programme corresponds to the welding wire and shield gas in use. The check is performed by briefly pressing the Synergic PROGRAM button (9), after which the displays show the material group and the programme number. Consult the above-mentioned table for the wire type and gas that correspond with the programme number.

Set the desired welding power via potentiometer 14 and the arc length via potentiometer 16.

### 3.3. SETUP FUNCTIONS (10)

The unit is equipped with a number of functions that can be selected. Parameters can be set via the SETUP function. The SETUP function is activated by pressing the SETUP button (10) for >1 second. The adjustable parameter is selected via the left-hand potentiometer (14), the name of which is shown on display No. 2. The value of the parameter in question is adjusted via the right-hand potentiometer (16), the value of which is shown on the display (8). The parameters and their possible values are:

#### **Normal MIG -welding SETUP -parameters**

Name of parameter	Name on display	Parameter values	Factory setting	Description
<b>Pre Gas Time</b>	PrG	0,0...9,0 s	0,1 s	Pre gas time 0-9,9 s
<b>Post Gas Time</b>	PoG	Aut, 0,1 ... 32,0 s	Aut	Post gas time Aut = automatic, depending on welding current 0,1-32 s
<b>Creep Start Level</b>	Cre	10...170%	50 %	Percentage of wire feed speed: 10 % slowed start 170 % accelerated start
<b>Start Power</b>	StA	-9 ... +9	(0)	Strength of start pulse
<b>Post Current Time</b>	PoC	-9...+9	0	Post current

#### **Synergic MIG -welding SETUP -parameters**

Name of parameter	Name on display	Parameter values	Factory setting	Description
<b>Pre Gas Time</b>	PrG	0,0...9,0 s	0,1 s	Pre gas time 0-9,9 s
<b>Post Gas Time</b>	PoG	Aut, 0,1 ... 32,0 s	Aut	Post gas time Aut = automatic, depending on welding current 0,1-32 s
<b>Creep Start Level</b>	Cre	10 ... 170 %	(50 %)	Percentage of wire feed speed: 10 % slowed start 170 % accelerated start
<b>Hot Start Level</b>	Hot	-50 ... 75 %	(30 %)	Percentage of welding power: -50 % cold and +75 % hot
<b>Hot Start 2T Time</b>	H2t	0,0...9,9 s	(1,2 s)	The duration of the hot start in seconds with 2T function
<b>Crater Fill Step Level</b>	CrS	10 ... 100 %	(30 %)	The welding power at the beginning of the crater fill stage as a percentage of the welding power preset value
<b>Crater Fill Time</b>	CrT	0,0...9,9 s	(2,0 s)	The duration of the crater fill stage in seconds
<b>Crater Fill End Level</b>	CrL	10 ... 90 %	(30 %)	The welding power at the end of the crater fill stage as a percentage of the welding power preset value

<b>Start Power</b>	StA	-9 ... +9	(0)	Strength of start pulse
<b>Post Current Time</b>	PoC	-9 ... +9	(0)	Post current
<b>Synergic MIG Unit</b>	Unl	mm, mm/min, A	(m/min)	In 1-MIG and FR-MIG welding, parameter unit shown in left-hand display/ Average current
<b>Cable Compensation</b>	CAL	-5.0 ... 9.0 V/100 A	(1.0 V/100 A)	Cable compensation (MIG) for voltage drop

**⚠ NOTE!** In crater fill, the initial value of the welding power must be greater than the final value, and therefore the adjustment ranges for the initial and final values are restricted automatically, if necessary.

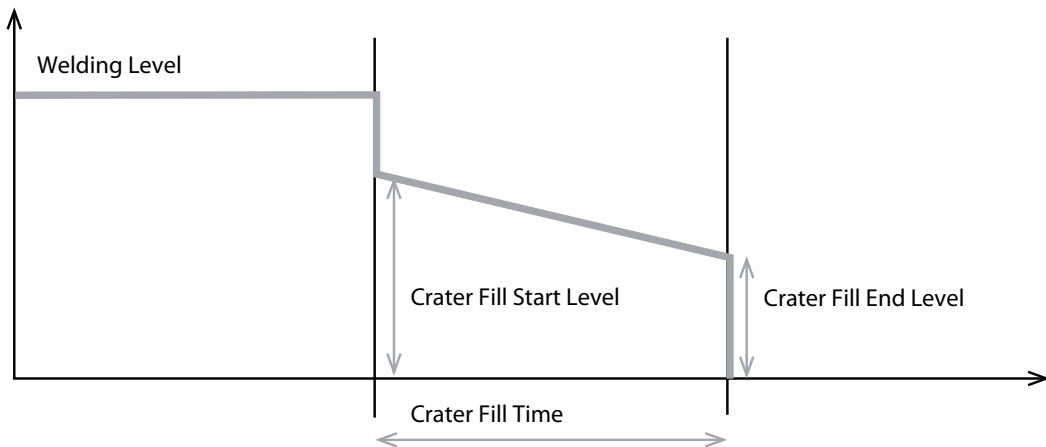

### **Common SETUP-parametres for MIG-processes (only SF53, SF55)**

Name of parameter	Name on display	Parameter values	Factory setting	Description
<b>Device Address</b>	Add	3 or 6	(3)	Wire feeder bus address
<b>Using features of PMT Gun</b>	Gun	OFF, on	(on)	OFF = other gun ON = PMT gun
<b>GasGuard Corrected</b>	GG	no, yES	(no)	Implementation of gas guard
<b>Code Entry</b>	Cod	---, Ent	(---)	Programming extra values, see page 18
<b>Restore Factory Settings</b>	FAC	OFF, PAn, All	(OFF)	Restores factory settings when 'on' is selected, exit SETUP mode

Each welding process has got SETUP-parameters of its own. For instance synergic MIG post gas time has got no effect on normal MIG post gas time.

The value of the parameter is immediately recorded in the memory. Exit SETUP mode by holding down the new SETUP button or by briefly pressing the ON/OFF button.

## 4. OPERATIONS OF REMOTE CONTROL UNITS IN MSF WIRE FEED UNIT

**R20**

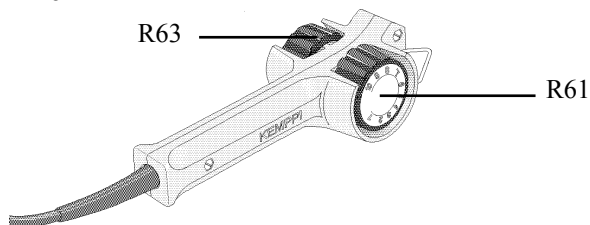

	<b>R63</b>	<b>R61</b>
<b>MIG</b>	Setting for wire feed: 1...25 m/min	Setting for voltage: 10 V...max. voltage of power source (35...46 V)
<b>MEMORY</b>	Channel selection: 1...5 corresponding to settings 1, 4, 6, 8, 10 of knob	NO OPERATION
<b>SYNERGIC MIG</b>	Setting for power (wire feed speed): according to wire min. ... max.	Fine adjustment for arc length: 1...10
<b>MMA</b>	Setting for power: 10 A...max. power of power source	NO OPERATION

**R10, RMT10**

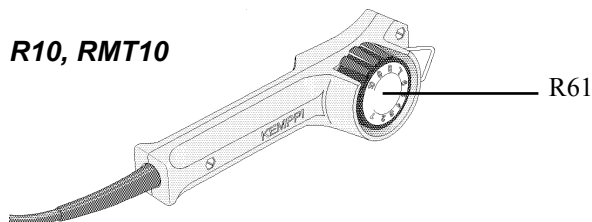

	<b>R61</b>	<b>RMT10 remote control unit for PMT/WS gun</b>
<b>MIG</b>	Setting for wire feed: 1...25 m/min	Setting for wire feed: 1...25 m/min
<b>MEMORY</b>	Channel selection: 1...5 corresponds in the R10 settings 1, 4, 6, 8, 10 of knob	Channel selection 1...5
<b>SYNERGIC MIG</b>	Setting for power (wire feed speed): according to wire min. ... max.	Setting for power (wire feed speed) according to wire min. ... max. (see page 16)
<b>MMA</b>	Setting for power: 10 A...max. power of power source	NOTE! RMT10 NO OPERATION

---

## 5. FASTMIG™ ERROR CODES

The existence of possible faults in the equipment is investigated in connection with each wire feed unit start-up. If a fault is detected, the fault in question will be indicated as an 'Err' message on the panel display.

### **Error code examples:**

#### **Err 2: Undervoltage**

The device has stopped because it has detected a mains undervoltage that disturbs welding. Check the quality of the supply network.

#### **Err 3: Overvoltage**

The device has stopped because dangerously high temporary voltage surges or a continuous overvoltage has been detected in the electric network. Check the quality of the supply network.

#### **Err 4: Power source is overheated**

The power source has overheated. The cause may be one of the following:

- The power source has been used for a long time at maximum power.
- The circulation of cooling air to the power source is blocked.
- The cooling system has experienced a failure.

Remove any obstacle to air circulation, and wait until the power source fan has cooled down the machine.

#### **Err 5: Water unit alarm**

The water circulation is blocked. The cause may be one of the following:

- Congestion or disconnection in the cooling pipeline
- Insufficient cooling liquid
- Excessive cooling liquid temperature

Check the circulation of the cooling liquid and the air circulation of the water unit.

#### **Err 54: No data communication from power source**

The data transmission between the power source and the wire feed unit has been cut off or is defective. Check the extension lead and connections.

#### **Err 55: Power source is busy**

The communication channel is busy. The power source is being used by another wire feed unit or the programming for some other device in the channel (e.g. control panel) is in progress.

#### **Err 61: The water unit is not found**

Water unit is not connected to the equipment or there is a connection fault.

Connect up the water unit or change the setting of the unit to gas-cooled, if you are using a gas-cooled welding gun

#### **Err 153: Overheating of liquid-cooled PMT gun**

When starting to weld or during welding, the overheat protection on the liquid-cooled MIG welding gun has activated. Check that there is sufficient liquid in the cooling unit and that air is circulating freely through it. Ensure that liquid is circulating freely through the cooling hoses.

#### **Err 154: Overloading of the wire feed motor**

The welding has been interrupted because the loading of the wire feed motor has risen to a high level. The cause of this could be a blockage of the wire line. Check the wire conduit, contact tip and feed rolls.

#### **Err 155: Warning of the wire feed unit overloading**

The wire feed motor load level has risen. The cause could be dirty wire conduits or a gun cable twisted into sharp curves. Check the state of the gun and clean the wire line if necessary

#### **Err 171: Configuration not found for the device**

The equipment's internal data transmission has been cut off. The optional features cannot be used. Turn off the machine, detach the welding gun and re-start the machine. If an error code does not appear in the display, the fault lies in the welding gun. If this error code pertains, contact maintenance.

### **Err 172: A wrong configuration code has been supplied**

This error code appears after entering the licence code. The licence code is incorrect or an error has occurred when entering the code. Check that the licence code matches the serial number, and enter the code again.

### **Err 201: Use of PMT gun is prevented**

You try to use the PMT welding gun, but the necessary settings have not been entered into the machine's control panel. Select 'PMT gun' from the control panel SETUP menu, if you wish to use it. This fault can also occur with other guns, if the trigger contacts are bad or dirty.

### **Err 221: Two wire feeders connected with the same device address.**

Two wire feed units have the same device address. Define different addresses for the devices as follows:

1. Press any button on either control panel (except the ESC button). "Add" (Device Address) is displayed.
2. Change the device address using the right-hand control knob.
3. Return to normal status by pressing again any button on the control panel.

The machines will return to normal status within 15 seconds.

### **Other error codes:**

The machine can show codes not listed here. In the event of an unlisted code appearing, contact an authorised Kemppi service agent and report the error code shown.

## **6. SERVICE, OPERATION DISTURBANCES**

The amount of use and the working environment should be taken into consideration when planning the frequency of maintenance of MSF. Careful use and preventive maintenance will help to ensure trouble-free operation.

The following maintenance operations should be carried out at least every six months:

Check:

- The wear of the grooves of the feed rolls. Excessive wear of grooves causes problems in wire feed.
- The wear of the wire guide tubes of wire feed. Badly worn feed rolls and wire guide tubes should be discarded.
- The wire guide tube in the gun should be set as near the feed rolls as possible, but not touching them and the wire must follow a straight line from the end of the tube to the groove of the feed roll.
- Reel brake adjustment.
- Electric connections
  - \* Oxidised couplings must be cleaned
  - \* Loose couplings must be tightened

Clean dust and dirt from the equipment.



**When using compressed air, always protect your eyes with proper eye protection.**

In case of problems contact your KEMPPPI dealer.

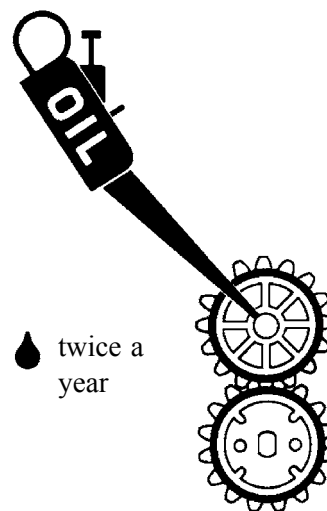

## 7. DISPOSAL OF THE MACHINE



Do not dispose of electrical equipment together with normal waste!

In observance of European Directive 2002/96/EC on Waste Electrical and Electronic Equipment and its implementation in accordance with national law, electrical equipment that has reached the end of its life must be collected separately and returned to an environmentally compatible recycling facility. As the owner of the equipment, you should get information on approved collection systems from our local representative.

By applying this European Directive you will improve the environment and human health!

## 8. ORDERING NUMBERS

MSF 53		6065300
SF 51	200 mm, LED	6085100
SF 52	200 mm, LED	6085200

MSF 55		6065500
MSF 57		6065700
SF 53	300 mm, LED	6085300
SF 54	300 mm, LED	6085400

KMS 300	3 ph 400V	6053000
KMS 400	3 ph 400V	6054000
KMS 500	3 ph 400V	6055000

Cooling unit Fastcool 10		6068100
Transport unit PM500		6185291

### **Accessories**

MSF 53 hanging frame (incl. KPS mounting set)		6185285
MSF 55 hanging kit		W001694
MSF 57 hanging kit		W002571
MSF 53 protection slides (incl. KPS mounting set)		6185286

### **Remote control units**

R10	5 m	6185409
R10	10 m	618540901
R 20	5 m	6185419
RMT 10 (for PMT MIG-gun)		6185475

### **MIG-guns**

PMT 25		6252514
PMT 27	3 m	6252713
PMT 27	4.5 m	6252714
PMT 32	3 m	6253213
PMT 32	4.5 m	6253214
PMT 35	3 m	6253513
PMT 35	4,5 m	6263514
PMT 42	3 m	6254213
PMT 42	4,5 m	6254214

PMT 50		3 m	6255013
PMT 50		4,5 m	6255014
PMT 30W		3 m	6253043
PMT 30W		4,5 m	6253044
PMT 42W		3 m	6254203
PMT 42W		4,5 m	6254204
PMT 52W		3 m	6255203
PMT 52W		4,5 m	6255204

WS 35	AL 1.2 mm	6 m	6253516A12
	SS 1.0 mm	6 m	6253516S10
WS 30 W	AL 1.2-1.6 mm	6 m	6253516S10
	SS 1.0 mm	6 m	6253046S10
	SS 1.2 mm	6 m	6253046S12
WS 30 W	AL 1.2 - 1.6 mm	8 m	6253048A12
	SS 1.0 mm	8 m	6253048S10
	SS 1.2 mm	8 m	6253048S12
WS 42 W	AL 1.2 - 1.6 mm	6 m	6254206A12
	SS 1.0 mm	6 m	6254206S10
	SS 1.2 mm	6 m	6254206S12
WS 42 W	AL 1.2 - 1.6 mm	8 m	6254208A12
	SS 1.0 mm	8 m	6254208S10
	SS 1.2 mm	8 m	6254208S12

### ***Interconnecting cables***

KWF 70-1,8-GH	6260401
KMS 70-1,8-WH	6260410
KWF 70-5-GH	6260405
KWF 70-5-WH	6260407
PROMIG 2/3 70-10-GH	6260326
PROMIG 2/3 70-10-WH	6260334

## 9. TECHNICAL DATA

		<b>MSF 53</b>	<b>MSF 55</b>	<b>MSF 57</b>
<b>Operating voltage (safety voltage)</b>		50 VDC	50 VDC	50 VDC
<b>Rated power</b>		100 W	100 W	100 W
<b>Load capacity (nominal values)</b>				
	60 % ED	520 A	520 A	520 A
	100 % ED	440 A	440 A	440 A
<b>Feeding mechanism</b>		4-roll feed	4-roll feed	4-roll feed
<b>Diameter of feed roll</b>		32 mm	32 mm	32 mm
<b>Wire feed speed</b>		0...25 m/min	0...25 m/min	0...25 m/min
<b>Filler wires</b>				
	∅ Fe, Ss	0,6...1,6	0,6...2,4	0,6...1,6 mm
	∅ Cored wire	0,8...1,6	0,8...2,4	0,8...2,0 mm
	∅ Al	1,0...1,6	1,0...2,4	1,0...2,4 mm
<b>Spool</b>				
	max. weight	5 kg	20 kg	20 kg
	max. size	∅ 200 mm	∅ 300 mm	∅ 300 mm
<b>Gun connector</b>		Euro	Euro	Euro
<b>Operation temperature range</b>		-20...+40 °C	-20...+40 °C	-20...+40 °C
<b>Storage temperature range</b>		-40...+60 °C	-40...+60 °C	-40...+60 °C
<b>Degree of protection</b>		IP 23	IP 23	IP 23
<b>External dimensions</b>				
	length	510 mm	620 mm	625 mm
	width	200 mm	210 mm	243 mm
	height	310 mm	445 mm	247 mm
<b>Weight</b>		9.4 kg	11.1 kg	12,5 kg

The products meet conformity requirements for CE marking.

---

## 10. TERMS OF GUARANTEE

Kemppi Oy provides a guarantee for products manufactured and sold by them if defects in manufacture and materials occur. Guarantee repairs must be carried out only by an Authorised Kemppi Service Agent. Packing, freight and insurance costs to be paid by orderer. The guarantee is effected on the date of purchase. Verbal promises which do not comply with the terms of guarantee are not binding on guarantor.

### ***Limitations on guarantee***

The following conditions are not covered under the terms of guarantee: defects due to natural wear and tear, non-compliance with operating and maintenance instructions, connection to incorrect or faulty supply voltage (including voltage surges outside equipment spec.), incorrect gas pressure, overloading, transport or storage damage, fire or damage due to natural causes i.e. lightning or flooding.

This guarantee does not cover direct or indirect travelling costs, daily allowances or accommodation.

Note: Under the terms of guarantee, welding torches and their consumables, feeder drive rolls and feeder guide tubes are not covered. Direct or indirect damage due to a defective product is not covered under the guarantee. The guarantee is void if changes are made to the product without approval of the manufacturer, or if repairs are carried out using non-approved spare parts.

The guarantee is also void if repairs are carried out by non-authorized agents.

### ***Undertaking guarantee repairs***

Guarantee defects must be informed to Kemppi or authorised Kemppi Service Agents within the guarantee period. Before any guarantee work is undertaken, the customer must provide proof of guarantee or proof of purchase, and serial number of the equipment in order to validate the guarantee.

The parts replaced under the terms of guarantee remain the property of Kemppi.

Following the guarantee repair, the guarantee of the machine or equipment, repaired or replaced, will be continued to the end of the original guarantee period.

KEMPPi OY  
PL 13  
FIN – 15801 LAHTI  
FINLAND  
Tel +358 3 899 11  
Telefax +358 3 899 428  
www.kemppi.com

KEMPPiKONEET OY  
PL 13  
FIN – 15801 LAHTI  
FINLAND  
Tel +358 3 899 11  
Telefax +358 3 734 8398  
e-mail: myynti.fi@kemppi.com

KEMPPi SVERIGE AB  
Box 717  
S – 194 27 UPPLANDS VÄSBY  
SVERIGE  
Tel +46 8 590 783 00  
Telefax +46 8 590 823 94  
e-mail: sales.se@kemppi.com

KEMPPi NORGE A/S  
Postboks 2151, Postterminalen  
N – 3103 TØNSBERG  
NORGE  
Tel +47 33 346000  
Telefax +47 33 346010  
e-mail: sales.no@kemppi.com

KEMPPi DANMARK A/S  
Literbuen 11  
DK – 2740 SKOVLUNDE  
DANMARK  
Tel +45 4494 1677  
Telefax +45 4494 1536  
e-mail:sales.dk@kemppi.com

KEMPPi BENELUX B.V.  
Postbus 5603  
NL – 4801 EA BREDA  
NEDERLAND  
Tel +31 765717750  
Telefax +31 765716345  
e-mail: sales.nl@kemppi.com

KEMPPi (UK) Ltd  
Martti Kemppi Building  
Fraser Road  
Priory Business Park  
BEDFORD, MK443WH  
ENGLAND  
Tel +44 (0)845 6444201  
Fax +44 (0)845 6444202  
e-mail: sales.uk@kemppi.com

KEMPPi FRANCE S.A.S.  
65 Avenue de la Couronne des Prés  
78681 EPONE CEDEX  
FRANCE  
Tel +33 1 30 90 04 40  
Telefax +33 1 30 90 04 45  
e-mail: sales.fr@kemppi.com

KEMPPi GmbH  
Otto – Hahn – Straße 14  
D – 35510 BUTZBACH  
DEUTSCHLAND  
Tel +49 6033 88 020  
Telefax +49 6033 72 528  
e-mail: sales.de@kemppi.com

KEMPPi SPOLKA z.o.o.  
Ul. Piłsudskiego 2  
05-091 ŻĄBKl  
POLAND  
Tel +48 22 7816162  
Telefax +48 22 7816505  
e-mail: info.pl@kemppi.com

KEMPPi WELDING MACHINES  
AUSTRALIA PTY LTD  
P.O. Box 404 (2/58 Lancaster Street)  
INGLEBURN NSW 2565  
AUSTRALIA  
Tel. +61 2 9605 9500  
Telefax +61 2 9605 5999  
e-mail: info.au@kemppi.com

Kemppi OY LIMITADA  
Av. Pdte. Edo. Frei Montalva 6001-81  
Conchalí, SANTIAGO,  
CHILE  
Tel +56-2-949 1990  
Telefax +56-2-949 1991  
e-mail: arturo.silva@kemppi.com

OOO KEMPPi  
Polkovaya str. 1, Building 6  
127018 MOSCOW  
RUSSIA  
Tel +7 495 739 4304  
Telefax +7 495 739 4305  
e-mail: info.ru@kemppi.com

ООО КЕМППИ  
ул. Полковая 1, строение 6  
127018 Москва  
Tel +7 495 739 4304  
Telefax +7 495 739 4305  
e-mail: info.ru@kemppi.com